

Important Safety Instructions

1. Read these instructions.
2. Keep these instructions.
3. Heed all warnings.
4. Follow all instructions.
5. Do not use this apparatus near water.
6. Clean only with dry cloth.
7. Do not block any ventilation openings. Install in accordance with the instructions.
8. Do not install near any heat sources such as radiators, heat registers, stoves or other apparatus (including amplifiers) that produce heat.
9. Do not defeat the safety purpose of the polarized or grounding-type plug. A polarized plug has two blades with one wider than the other. A grounding type plug has two blades and a third grounding prong. The wide blade or the third prong are provided for your safety. If the provided plug does not fit into your outlet, consult an electrician for replacement of the obsolete outlet – USA version only.

10. Protect the power cord from being walked on or pinched particularly at plug, convenience receptacles, and the point where they exit from the apparatus.
11. Only use attachments/accessories specified by the manufacturer.
12. Use only with the cart, stand, tripod, bracket, or table specified by the manufacturer, or sold with the apparatus. When a cart is used, use caution when moving the cart/apparatus combination to avoid injury from tip-over.
13. Unplug this apparatus during lightning storms or when unused for long periods of time.
14. Refer all servicing to qualified service personnel. Servicing is required when the apparatus has been damaged in any way, such as power-supply cord or plug is damaged, liquid has been spilled or objects have fallen into the apparatus, the apparatus has been exposed to rain or moisture, does not operate normally, or has been dropped.
15. To reduce the risk of fire or electric shock, Do not expose this appliance to Rain or Moisture.
16. The Shock Hazard Marking and Associated Graphical Symbol is provided on the bottom panel of unit.
17. Apparatus shall not be exposed to dripping or splashing and no objects filled with liquids, shall not be placed on the apparatus.

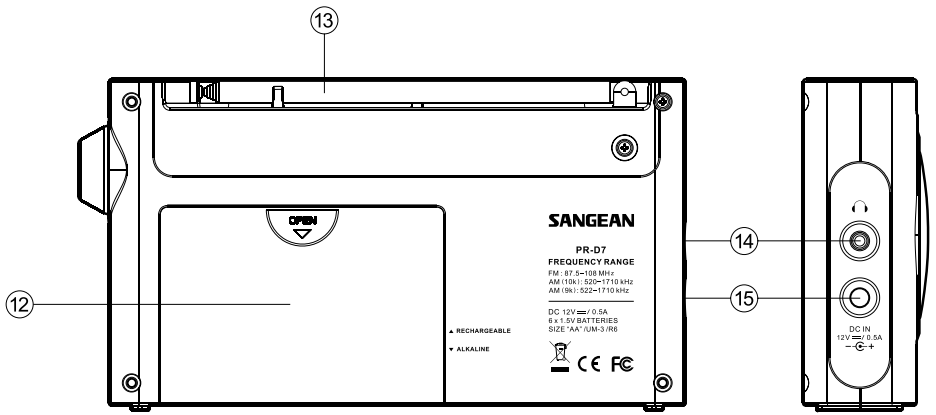
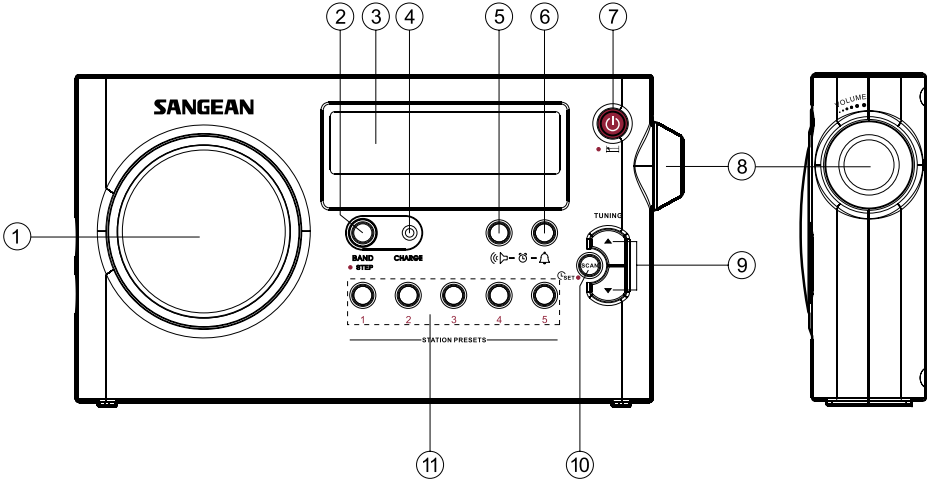
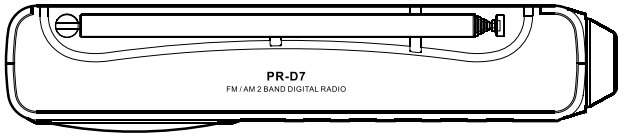

Controls

- ① Speaker
- ② Band Selection
- ③ LCD Display
- ④ Charge LED indicator
- ⑤ Alarm by radio
- ⑥ Alarm by buzzer
- ⑦ Power/Auto shut off button
- ⑧ Volume Control
- ⑨ Tuning Control
- ⑩ Station Scan and Time Set
- ⑪ Station Presets
- ⑫ Battery Compartment
- ⑬ FM Telescopic Antenna
- ⑭ Headphone socket
- ⑮ DC In socket

GB

LCD Display

- Ⓐ Radio Band
- Ⓑ Station Frequency
- Ⓒ Sleep and Snooze
- Ⓓ Clock Set
- Ⓔ Clock
- Ⓕ Buzzer Alarm
- Ⓖ Radio Alarm
- Ⓗ PM
- Ⓘ Frequency unit
- Ⓙ Preset Station
- Ⓚ Battery Power Indicator

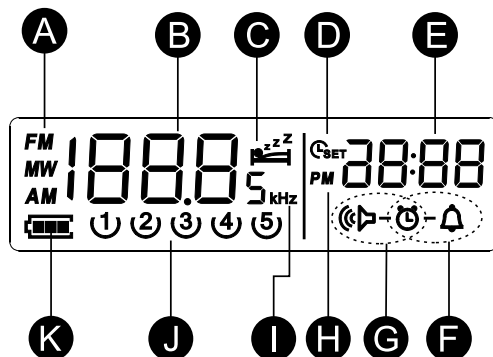

Battery operation using alkaline batteries

1. Remove the battery cover on the back of the unit by sliding the cover in the direction of the arrow.
2. Insert 6 x AA (UM3, LR6) alkaline batteries into the spaces in the compartment. Take care to ensure the batteries are inserted with correct polarity as shown inside the battery compartment.
3. Slide the battery switch to the Alkaline position and then replace the battery cover.

Important:

when using alkaline batteries, the battery switch must be placed in the alkaline position. Failure to do so could result in serious damage to the batteries or radio.

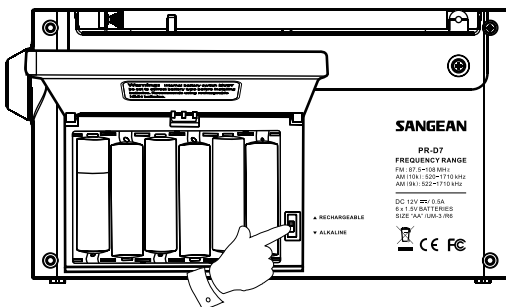

Reduced power, distortion and a “ stuttering “ sound are all signs that the batteries may need replacing.

If the radio is not to be used for any extended of time, it is recommended that the batteries are removed from the radio.

We would suggest for economy that the radio is used via the supplied AC power adaptor whenever possible, with battery operation for occasional or stand-by use only. If extended listening using anticipated, then the use of rechargeable batteries is suggested.

Battery operation using rechargeable batteries

GB

1. Remove the battery cover on the back of the unit by sliding the cover in the direction of the arrow.
2. Insert 6 x rechargeable AA (UM3) batteries into the spaces in the compartment. Take care to ensure all batteries are inserted with the correct polarity as shown inside the battery compartment. The radio is designed to be used with Nickel Metal Hydride (NiMH) rechargeable batteries.
3. Slide the battery switch to the Rechargeable position and then replace the battery cover.
4. Insert the supplied AC power adaptor into the DC IN socket on the left hand side of the radio and plug the adaptor into a standard 13A mains socket outlet.
5. The charge light will flash indicating batteries are charging. Batteries will be fully charged in around 7 hours while charge LED will stop flashing.

Important:

when using rechargeable batteries, the battery switch must be placed in the Rechargeable position. Batteries will only be charged when the radio is switched off and connected to the AC adaptor.

6. Reduced power, distortion and a “ stuttering “ sound are all signs that the batteries may need recharging. Charge LED will be lighted when batteries have no power to turn on the radio.
7. If the radio is not to be used for any extended period of time, it is suggested that the batteries are removed from the radio.

Note:

Please be aware that the rechargeable battery undergoes a time of charging and discharging, the battery capacity will gradually decline during over time with repeated use. The battery icon shows the remaining battery life on the LCD screen when the radio is turned on. In addition, the calculation of charging time is based on the capacity of the rechargeable battery and charging current power output of the charger. The two examples in the below table are for your reference only.

PR-D7(p6)

Size	Model	Capacity (mAh)	Charging Current (mA)		Charging Time (hrs)	
AA	GP2700	2600	Approx.	350	Approx.	7.5
	GP1800	1800		350		5

Using the supplied AC power adaptor

GB





The supplied AC adaptor is 12 Volts DC output 500 mA center pin positive.

1. Insert the adaptor plug into the DC IN socket on the left hand side of the radio.
2. Plug the adaptor into a standard 13A mains socket outlet. Whenever the adaptor is plugged into the radio and switched on the mains, the batteries are automatically disconnected.

If the adaptor is plugged into the radio but not the mains is not switched on then the radio will run from the batteries if fitted.

The AC adaptor should be disconnected from the mains supply and the radio when not in use.

Setting the clock

1. Clock can be set either the radio is power on or off.
2. Display will show “ - : - - “ when the batteries are installed when the radio is connected to the mains supply.
3. Press and hold the  button for more than 2 seconds, display will flash time set symbol  and also the hour digit, followed by a beep.
4. Press Tuning Up/Down to set required hour.
5. Press  button again, the minute digits will flash.
6. Press Tuning Up/Down to set required minute.
7. Press  button to complete time setting.

Operating the radio

This radio is equipped with three tuning methods – Scan tuning, Manual tuning and Memory presets recall.

Scan tuning

1. Press the Power button to turn on the radio.
2. Select the required waveband by pressing the Band button. For FM band fully extend and rotate telescopic aerial to get best reception. For AM (MW) band, rotate the radio to get best signal.
3. Press and release Scan button (long press Scan button more than 2 seconds will activate time setting), the radio will up search and stop automatically when it finds a radio station with good signal. Press the Scan button again to pick up the found station. The radio will continue to search next available stations if you do not press Scan button again when it finds a radio station.
4. Rotate the Volume Control to get required sound level.
5. To turn off the radio, press the Power button. Display will show OFF.

Manual tuning / station searching

1. Press the Power button to turn on the radio.
2. Select the required waveband by pressing the Band button.
Adjust the antenna as described above.
3. A single press on either the Tuning Up or Down button will change the frequency in the following increments:
FM: 50 or 100 kHz
AM (MW): 9 or 10 kHz
4. Press and hold either Tuning Up or Down button until the frequency in the display begins to change rapidly. Release the button.
Your radio will search the selected waveband and stop automatically when it finds a station of sufficient signal.
5. Rotate the Volume control to get required sound level.
6. To turn off the radio, press the Power button.
Display will show off.

GB

Storing stations in preset memories

There are 5 memory presets for each waveband.

1. Press the Power button to turn on the radio.
2. Tune to a required station using one of the methods previously described.
3. Press and hold down the required preset until the radio beeps.
The preset number will appear in the display and the station will be stored under chosen preset station.
4. Repeat this procedure for the remaining presets.
5. Stations stored in preset memories can be overwritten by following above procedures.

Recalling stations from preset memories





1. Press the Power button to turn on the radio.
2. Select the required waveband.
3. Momentarily press the required preset button, the preset number and station frequency will appear in the display.

Setting the radio alarm

When the radio alarm is selected, the radio will turn on and play the chosen radio station at the chosen alarm time. The radio alarm will continue for an hour unless turned off by pressing the Power button. Press the Power button whilst the alarm is activated will cancel the alarm for 24 hours.

Note:

Radio alarm can be activated only until both radio alarm time and radio alarmed station are set. Radio alarm will be automatically switched to buzzer alarm when the radio is in low battery status or the selected radio alarm station signal is too weak.

1. The radio alarm can be set either radio is on or off.
2. Press and hold the radio alarm button  for 2 seconds, the radio will show radio alarm symbol  followed by a beep.
3. Display Hour will flash, using Tuning up/Down button to select the hour then press  button again to confirm hour setting.
- 4 Press the Tuning up/down button to select the desired minute and press  button to confirm minute setting.
5. While radio alarm symbol is flashing, press the Tuning up/down to select desired wake-up band and station, then press  button to confirm the selection. Radio alarm setting is now completed. Active alarms are shown using alarm indicator on the display.
6. To cancel a sounding alarm, press the Standby button to cancel a sounding alarm.
7. To cancel the radio alarm setting before the alarm sounds off, press and hold the radio alarm button for 2 seconds (followed by a beep).





Note:

If the signal of the set station cannot be found, the buzzer alarm will be used instead.

Setting the HWS (Humane Wake System) buzzer alarm

A beep will activate when selecting the HWS alarm. The alarm beep will increase in volume every 15 seconds for one minute followed by one minute silence before repeating the cycle.

The HWS alarm will sound for an hour until turning off by pressing the Power button. Press the Power button whilst the alarm is activated will cancel the alarm for 24 hours.

1. The HWS buzzer alarm can be set wither radio is on or off.
2. Press and hold the HWS buzzer alarm button  for 2 seconds, the symbol  will show on the display followed by a beep. Now the display hour digit will flash.
3. Press Tuning Up/Down button to select required alarm hour, then press  button again, the minute digit will then flash.
4. Press Tuning Up/Down button to select required alarm minute, then press  button again to complete alarm setting. Display will appear  when buzzer alarm has been set.
5. To cancel a sounding alarm, press the Standby button to cancel a sounding alarm.
6. To cancel the buzzer alarm setting before the alarm sounds off, press and hold the buzzer alarm button for 2 seconds (followed by a beep).



Snooze function

1. Whilst the alarm is activated, press any buttons except the Power button will activate the snooze function. The radio or HWS buzzer alarm will be silenced with interval of 5 minutes.
2. The display will flash both the snooze symbol  and the alarm symbol. The snooze function can be repeatedly during the one hour that the alarms are active.

GB

Sleep function

The sleep timer will automatically switched off the radio after a pre-set time has elapsed.

1. Press and continue to hold down the Power button for more than 2 seconds, followed by a beep, the display will cycle through the available sleep timers in the order of 60-45-30-15-120-90-60. Release the Power button when the required sleep timer appears in the display. The  symbol will appear in the display and the radio will play the last station selected.
2. To cancel the sleep function, press the Power button. The  symbol will disappear and radio is off.

Display backlight

Press any buttons will illuminate the LCD display for approx. 10 seconds. During scanning stations and alarm activated will also automatically illuminate the display.

Software version

The software display cannot be altered and is just for your reference.

1. Turn off the radio.
2. Press the Band/step button for 2 seconds until the software version number (e.g. P01) shown on the display.

Time format

3. Continue pressing the Band/step button until '24H' or '12H' shown on the display followed by a beep.
4. Press the Tuning up/down button to choose the desired selection and press the Band/ step button to confirm the setting.

Setting tuning step

Tuning steps in some countries are different from where you purchase the radio. If you buy the radio in Europe and intend to use in Northern America or some Southern American countries. You may have to adjust tuning step so that the radio can work properly.

5. After the FM range setting is completed, the display will switch to tuning step setting. Press the Tuning up/ down button to choose the desired FM tuning step (50 kHz or 100 kHz) and press the Band/step button to confirm the setting.
6. After the confirmation of FM tuning step, press the Tuning up/down button to choose the desired AM tuning step (9kHz or 10 kHz) and press the Band/step button to confirm the setting.

Headphone socket

A 3.5 mm headphone socket located on the left hand of your radio is provided for use with either headphones or an earpiece. Insert a plug automatically mutes the internal speaker.

Specifications

Power Requirements

AC Power adaptor: DC 12V 500 mA center pin positive

GB

Batteries: 6 x UM-3 (AA size, LR6)

Battery life:

Approx. 38 hours of listening for 4 hours a day at normal volume using alkaline cells.

Frequency Coverage:

FM 87.50 – 108 MHz

MW 522 – 1710 kHz (9 kHz/step) or

MW 520 – 1710 kHz (10 kHz/step)

Circuit Feature

Loudspeaker: 3 inches, 8 ohm

Output Power: 1.0 Watt using AC power adaptor

Headphone socket: 3.5 mm dia

Aerial System: Telescopic aerial

The company reserves the right to amend the specifications without notice.



If at any time in the future you should need to dispose of this product please note that: Waste electrical products should not be disposed of with household waste. Please recycle where facilities exist. Check with your Local Authority or retailer for recycling advice. (Waste Electrical and Electronic Equipment Directive)